

UNIKA PRODUCT INFO

UNIKA – GM LAN – CONVERSO

Parrot UNIKA

Parrot UNIKA is an installable interface that connects your vehicle's steering wheel controls to any hands-free system in the Parrot Mki series, putting all the features of your Parrot hands-free system within easy reach, whatever the circumstances. Integrated - the Parrot UNIKA solution is invisible inside the vehicle

Intelligent - compatible with all steering wheel controls

Universal - fits most vehicles on the market*

Simple - quick and easy to fit

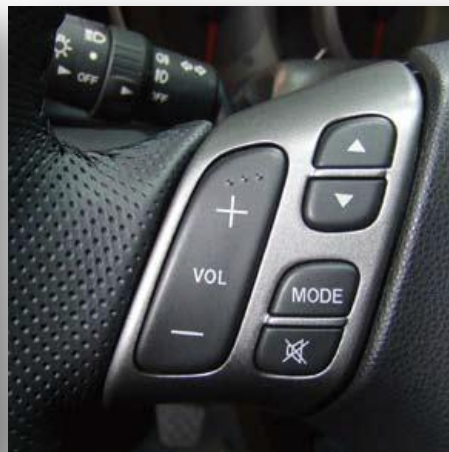

UNIKA PRODUCT INFO

TABLE OF CONTENTS

UNIKA PRODUCT APPLICATIONS

UNIKA – Universal application/selectable protocol system	Page 2-3
UNIKA CONVERSO – BMW Audi and Volkswagen	Page 4
UNIKA CONVERSO – Known factory Display compatibility	Page 5
UNIKA GM LAN – GM LAN Data System	Page 6

VEHICLE SPECIFIC WIRE LOCATIONS

VEHICLE CAN WIRE LOCATIONS	Page 7-8
VEHICLE RESISTIVE WIRE LOCATIONS	Page 9-13

UNIKA PRODUCT INFO

UNIKA COMPATIBILITY

MODEL: UNIKA UNIVERSAL

The UNIKA enables the factory steering wheel controls to operate the MKi9XXX series. This list is only the confirmed but should operate as expected on vehicles of the same generation, or protocol. Use list only for reference. If the vehicle operates on CAN, Resistive, K Bus and has supporting steering wheel buttons, it's very likely compatible.

Audi	
A3/S3	2004-2006
A3/S3	>2007
A4/S4	>2004
A4/S4	>2008
A6/S6	> 2004
Q7	> 2006
A5	> 2007
TT	> 2007
BMW	
1 Series	>2005
3 SERIES E90/E91/E92/E93	>2005
3 Series E46	<2004
5 SERIES E60 / E61	>2005
5 SERIES E39	<2004
X3	< 2007
X3	>2007
X5 (E53)	< 2006
X5 (E70)	>2007
Z4	>2003
X6	>2008
Mini	<2006
Mini	>2007

Chevrolet	
Matiz	>2004
Captiva	>2006
Aveo	>2006
Epica	>2007
Chevrolet-DAEWOO	
Tacuma	>2006
Kalos	>2004
Evanda	>2003
Leganza	>2002
Nubira	>2003
Lacetti	> 2007
Chrysler	
300C	>2006
Voyager	>2001
Grand Voyager	>2008
JEEP	
Compass	> 2006
Grand Cherokee	>2006
Cherokee	2001-2007
Grand Cherokee	99<2005

Dodge	
Nitro	> 2006
Caliber	> 2006
Journey	> 2008
Fiat	
Croma	>2005
Grande Punto	>2006
Idea	>2006
Stilo	>2006
Scudo	>2006
Bravo	>2007
500	>2007
Panda	>2005
16	>2006
Multipla	>2006
Ducato	>2006
Marea	>2002
Barchetta	>2002

UNIKA PRODUCT INFO

UNIKA COMPATIBILITY CONTINUED

MODEL: UNIKA UNIVERSAL

Ford	
Fiesta	2002-2005
Fiesta	2006-2008
Focus	2002-2005
Focus	>2006
C-Max	>2006
S-Max	>2006
Mondeo	>2006
Fiesta	>2008
Kuga	>2008
Tourneo	>2007
Transit	>2006
Honda	
Civic	>2006
Accord	>2008
CR-V	>2006
FR-V	>2004
Hyundai	
Santa Fe	>2006
Santa Fe	>2009
Jaguar	
S-Type	>2004
X-Type	>2004
Kia	
Ceed	>2006
Sorento	>2006
Sorento	>2010
Soul	>2008
Venga	>2009

Land Rover	
Freelander II	>2007
Range Rover Vogue	>2007
Mazda	
2	>2006
3	>2006
5	>2006
6	>2008
CX7	>2007
Mercedes	
A-Class	>2003
B-CLASS (W245)	>2004
C-CLASS (W203)	>2003
E-CLASS (W211)	>2004
R-CLASS (W251)	>2006
S - CLASS (W221)	>2006
CLK (W209)	>2003
GL	>2007
SLK R170	>2003
SLK R171	>2003
SL R230	>2006
M-CLASS (W164)	>2006
Actros	>2007
C-CLASS (W203)	>2007
Sprinter	>2007
VITO W638	>2006
VIANO W639	>2006
Mitsubishi	
Pajero	>2007
Lancer	>2008
Outlander	>2007

Nissan	
Micra	>2007
X-Trail	>2007
Note	>2006
Navara	>2006
Qashqai	>2007
Murano	>2005
Pathfinder	>2005
350Z	>2008
Porsche	
Cayenne	>2006
Boxster	>2006
Suzuki	
Grand Vitara	>2006
Splash	>2008
SX4	>2006
Swift	>2006
Subaru	
Forester	>2007
Impreza	>2007
Toyota	
Yaris	2003-2005
Yaris	>2005
Corolla	>2004
Avensis	>2004
Rav-4	>2004
Camry	>2004
Prius	>2005
Auris	>2004
Hi-Ace	>2002
Hilux	>2010

Volkswagen	
Golf V	2004>
Golf Plus	2004>
GOLF PLUS	2008>
Touan	2004>
Passat	2004>
Touareg	2004>
Touareg	2007>
EOS	2007>
PASSAT CC	2008>
GOLF VI	2008>
Scirocco	2008>
Tiguan	2007>
Jetta	2007>
Multivan	2006>
Volvo	
V 70	>2006
XC 90	>2007

UNIKA ALL-IN-ONE

UNIKA CONVERSO COMPATIBILITY

MODEL: UNIKA CONVERSO

The UNIKA Converso is capable with of communicating to the MKi9xxx products. Converso is recommended for these vehicles to avoid communication conflict with the factory radio systems. Example: Pressing next track will also change tracks on the factory radio. This list is only the confirmed. It may work on more applications.



Bmw			
Series 1	2005->	2W CANBUS	READY
Series 3	2005->	2W CANBUS	READY
Series 5	2005->	2W CANBUS	READY
New X5	2007->	2W CANBUS	READY
Mini	2008->	2W CANBUS	READY
Series 5 GT	2008->	2W CANBUS	READY
Volkswagen			
Golf Plus	2004->	2W CANBUS	READY
Golf V	2004-2007	2W CANBUS	READY
Golf VI	2008->	2W CANBUS	READY
New Touareg	2007-2009	2W CANBUS	READY
Passat	2004-2009	2W CANBUS	READY
Passat	2010->	2W CANBUS	READY
Passat CC	2008->	2W CANBUS	READY
Scirocco	2008-2010	2W CANBUS	READY
Scirocco	2011->	2W CANBUS	READY
Sharan	2010->	2W CANBUS	READY
Tiguan	2007-2010	2W CANBUS	READY
Tiguan	2011->	2W CANBUS	READY
Touran	2004-2009	2W CANBUS	READY
Touran	2010->	2W CANBUS	READY



UNIKA PRODUCT INFO

UNIKA CONVERSO COMPATIBILITY

MODEL: UNIKA CONVERSO

DISPLAY COMPATIBILITY

The UNIKA Converso is capable with of displaying MKi9xxx information on the following vehicle displays, in addition to communicating with the factory steering wheel buttons. This list is only the confirmed. It may work on more applications based on factory radio.

Golf Plus	2004->	2W CANBUS	READY	MFA - MFA PLUS
Golf V	2004-2007	2W CANBUS	READY	MFA - MFA PLUS
Golf VI	2008->	2W CANBUS	READY	MFA - MFA PLUS
New Touareg	2007-2009	2W CANBUS	READY	MFA - MFA PLUS
Passat	2004-2009	2W CANBUS	READY	MFA - MFA PLUS
Passat	2010->	2W CANBUS	READY	MFA - MFA PLUS
Passat CC	2008->	2W CANBUS	READY	MFA - MFA PLUS
Scirocco	2008-2010	2W CANBUS	READY	MFA - MFA PLUS
Scirocco	2011->	2W CANBUS	READY	MFA - MFA PLUS
Sharan	2010->	2W CANBUS	READY	MFA - MFA PLUS
Tiguan	2007-2010	2W CANBUS	READY	MFA - MFA PLUS
Tiguan	2011->	2W CANBUS	READY	MFA - MFA PLUS
Touran	2004-2009	2W CANBUS	READY	MFA - MFA PLUS
Touran	2010->	2W CANBUS	READY	MFA - MFA PLUS



UNIKA PRODUCT INFO

UNIKA GM LAN

MODEL: UNIKA GM LAN

The UNIKA GM LAN is compatible with recent GM vehicles equipped with the GM LAN protocol. Please reference your specific vehicle protocol for compatibility.

Note: These vehicles may also be equipped with the CAN data system, do not connect to these wires.



UNIKA PRODUCT INFO

UNIKA VEHICLE CONNECTIONS

UNIKA KNOWN VEHICLE SPECIFIC CONNECTIONS

This guide has been produced as a reference for locating the data system communication wires required for UNIKA installation. Please use this guide only as a reference, always test prior to operation.

CAN BUS SYSTEMS

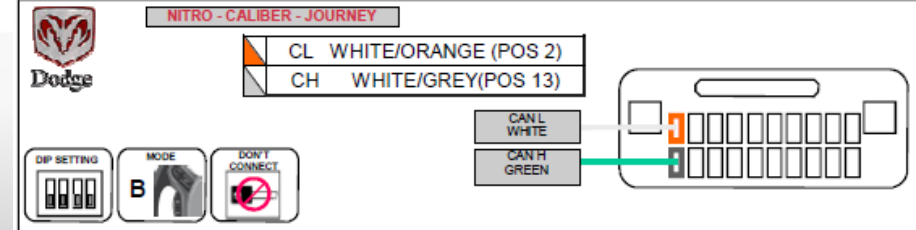
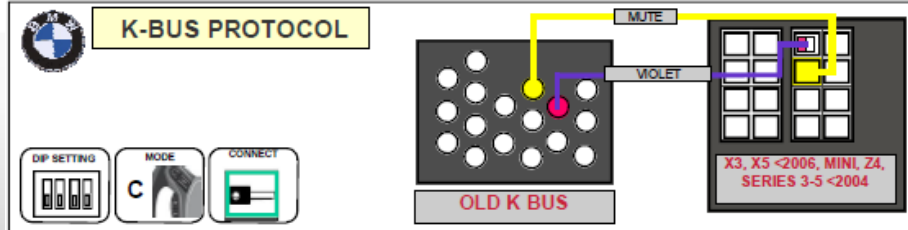
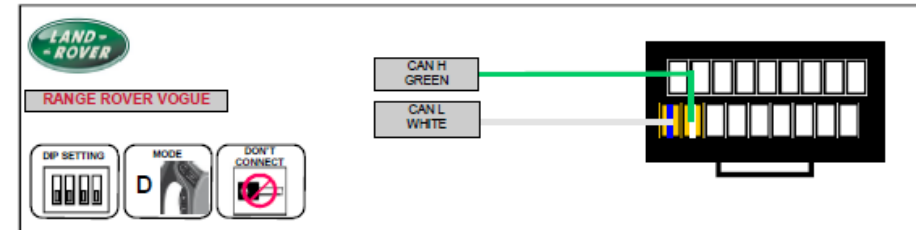
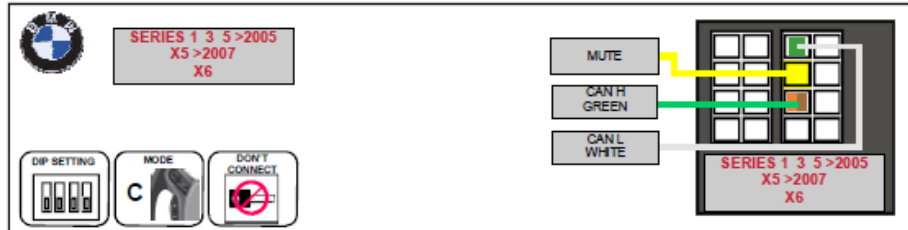
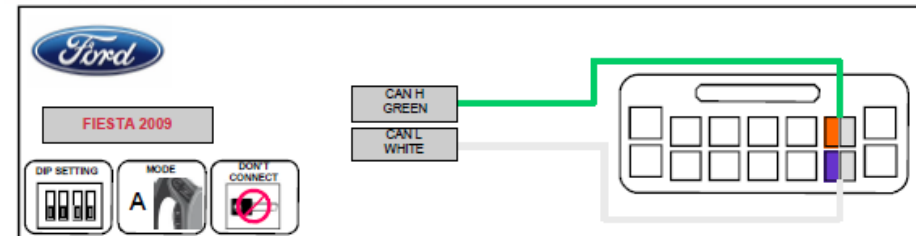
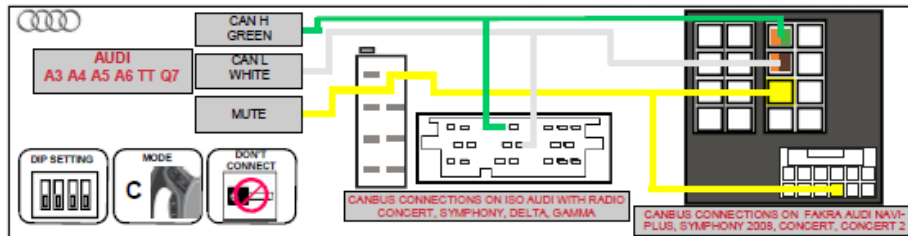

UNIKA PRODUCT INFO

UNIKA VEHICLE CONNECTIONS CONTINUED

CAN BUS SYSTEMS

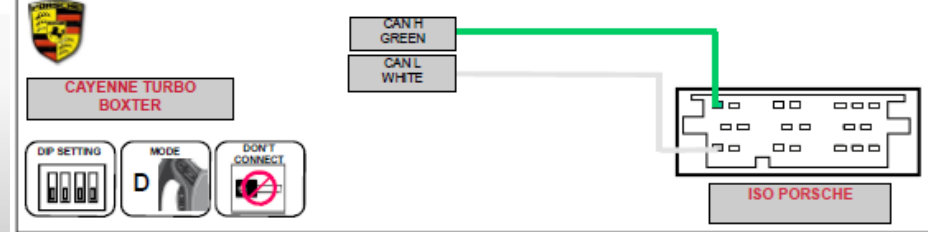
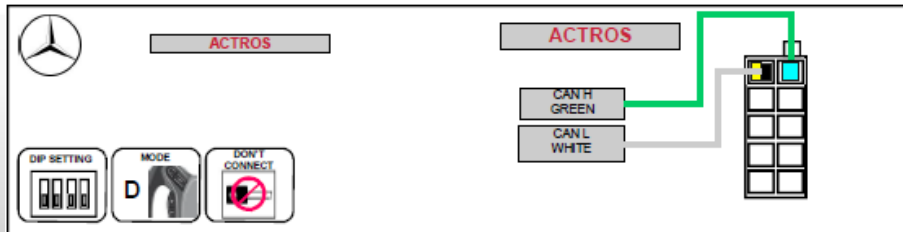
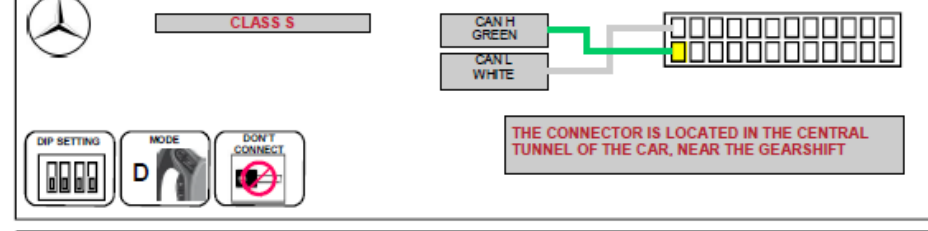
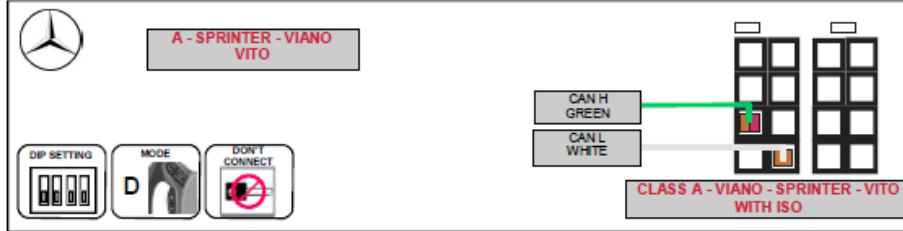
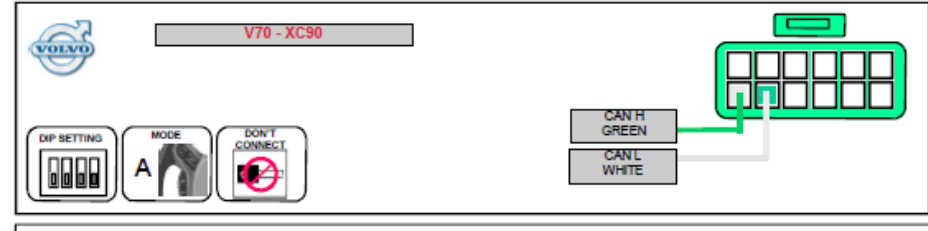
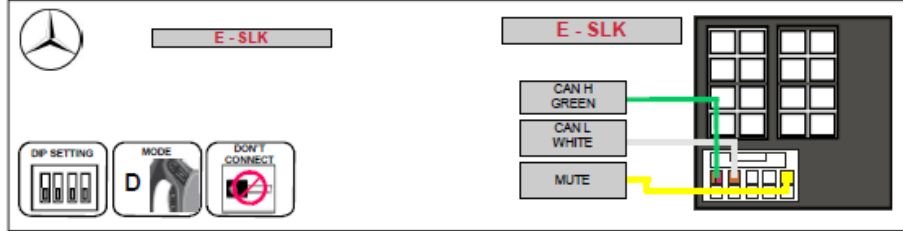
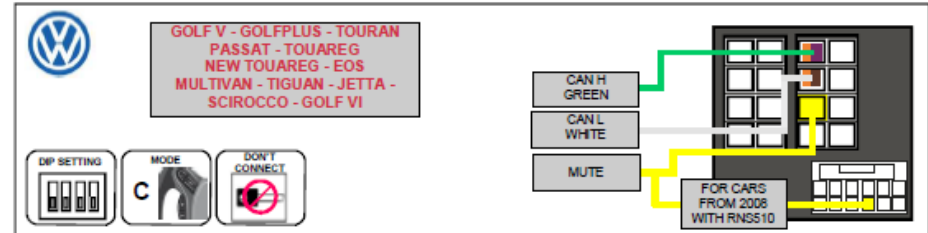
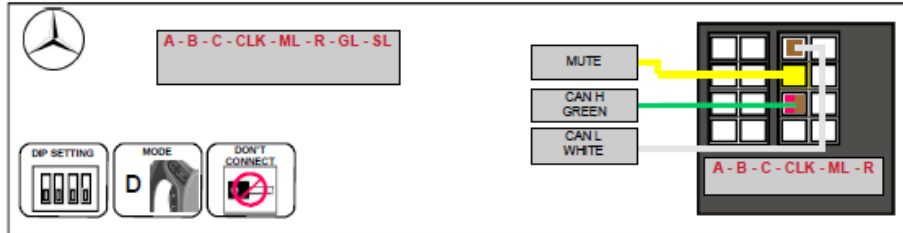

UNIKA PRODUCT INFO

UNIKA VEHICLE CONNECTIONS CONTINUED

RESISTIVE SYSTEMS

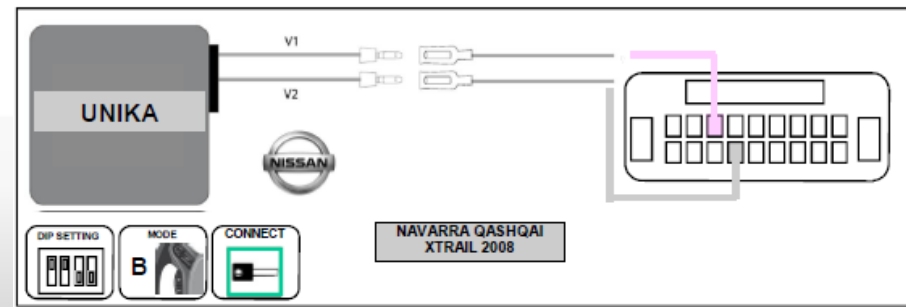
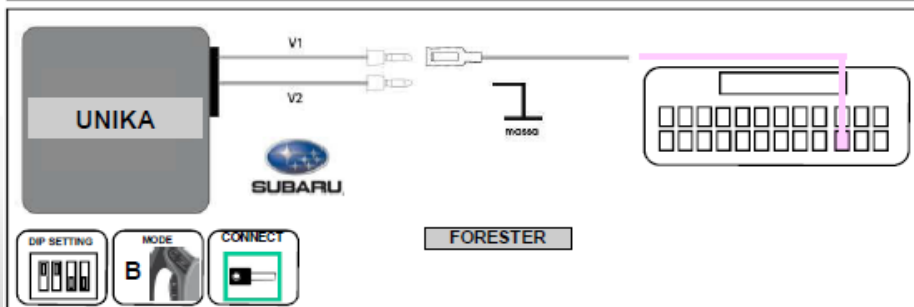
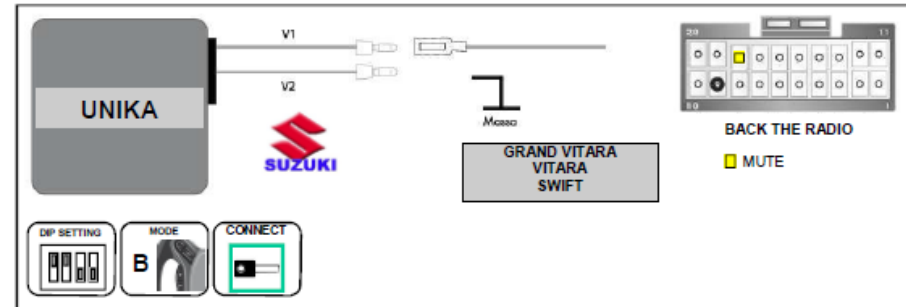
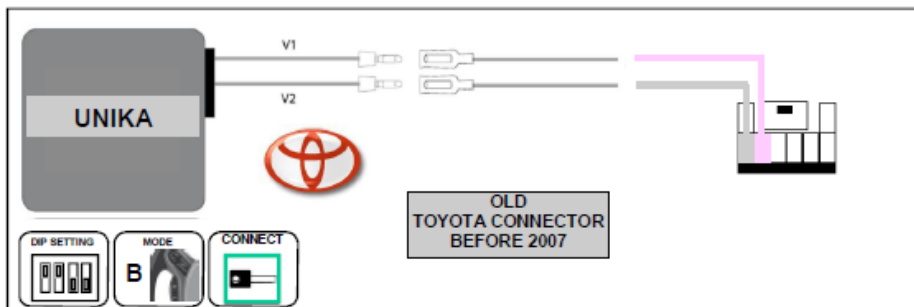
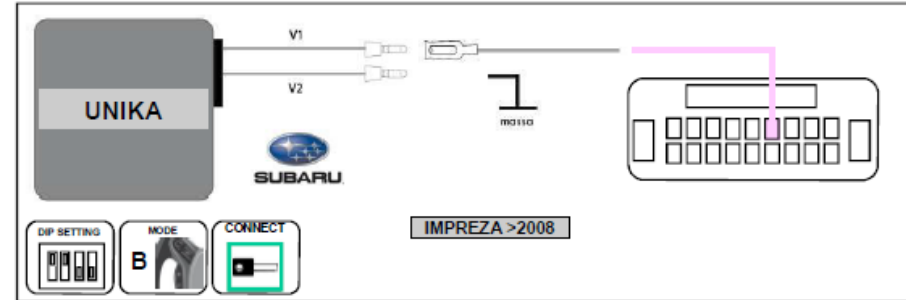
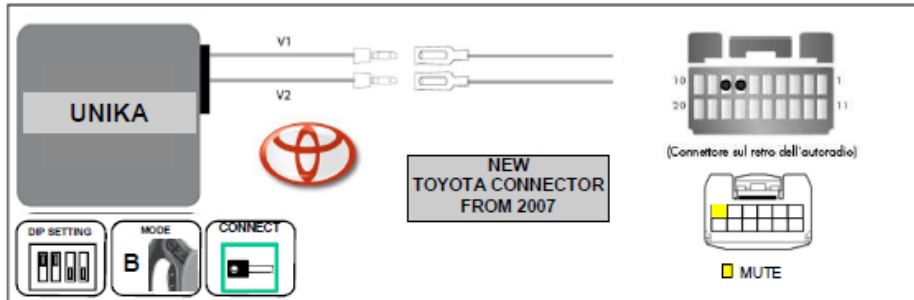

UNIKA PRODUCT INFO

UNIKA VEHICLE CONNECTIONS CONTINUED

RESISTIVE SYSTEMS

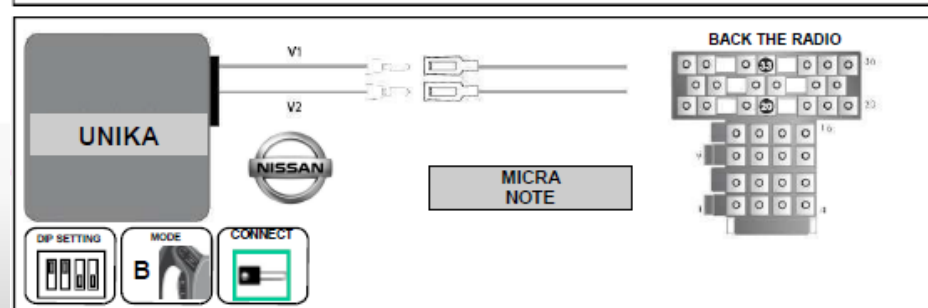
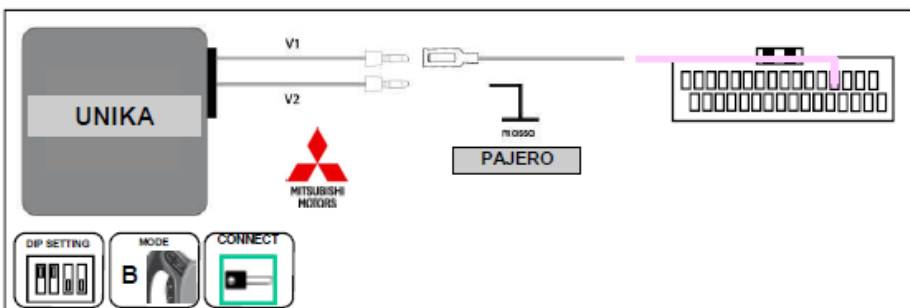
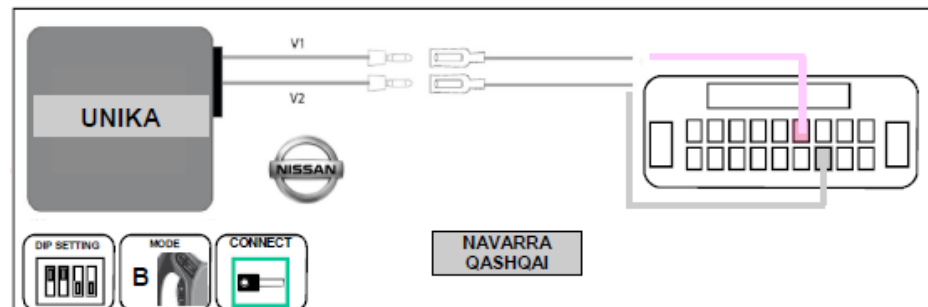
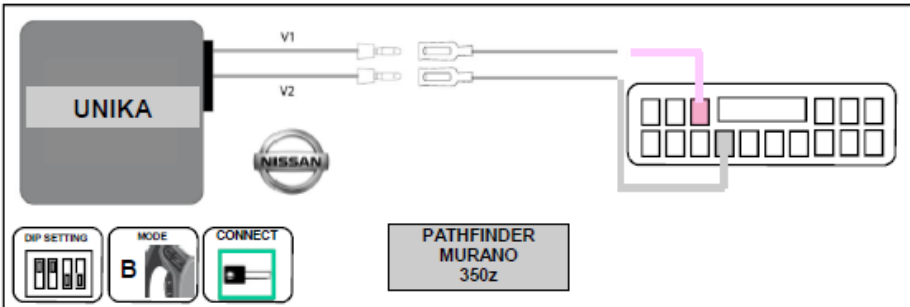
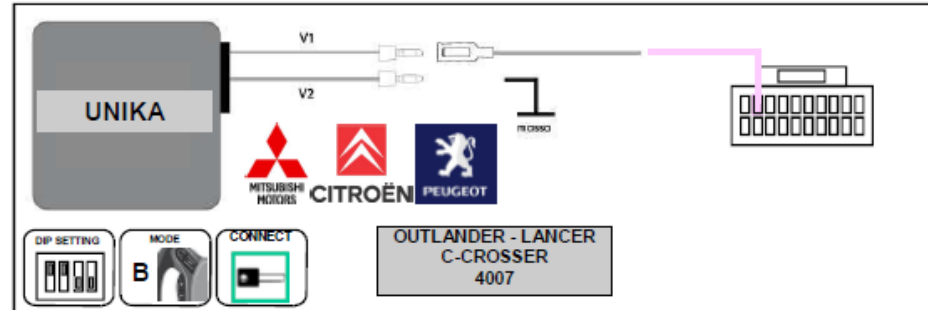
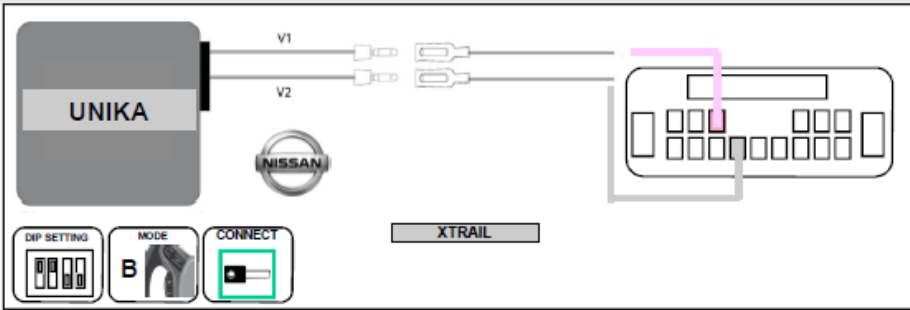

UNIKA PRODUCT INFO

UNIKA VEHICLE CONNECTIONS CONTINUED

RESISTIVE SYSTEMS

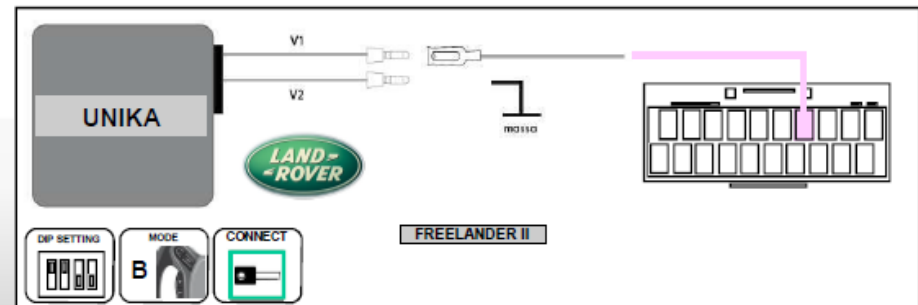
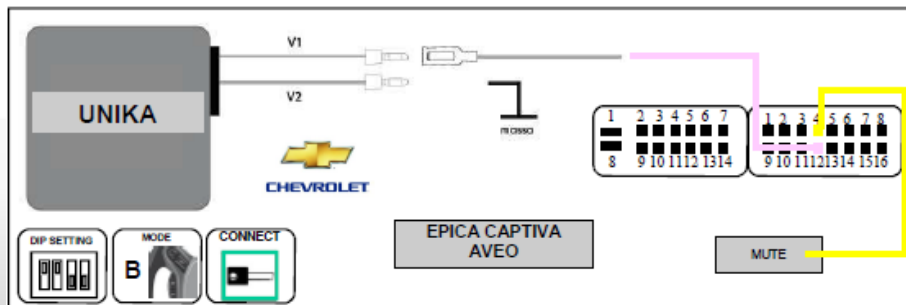
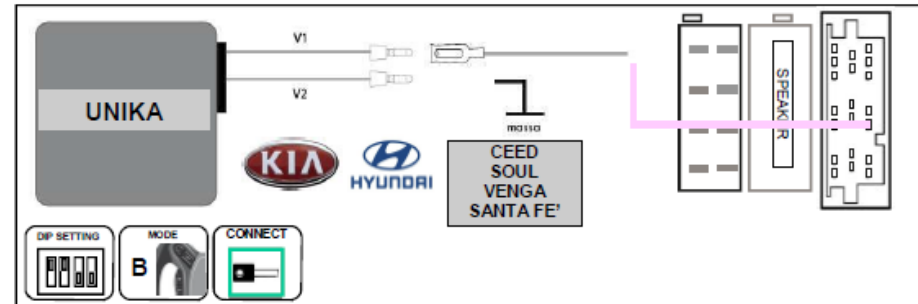
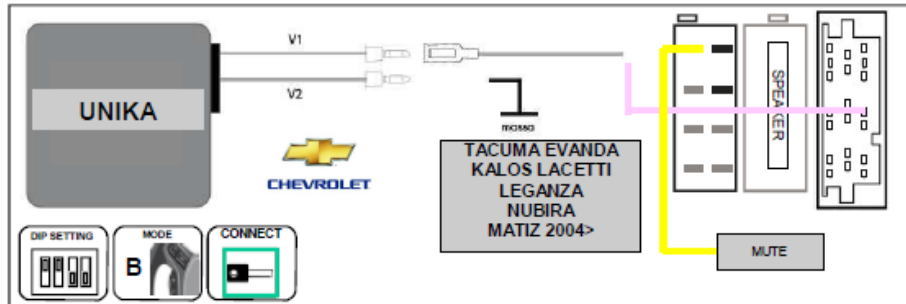
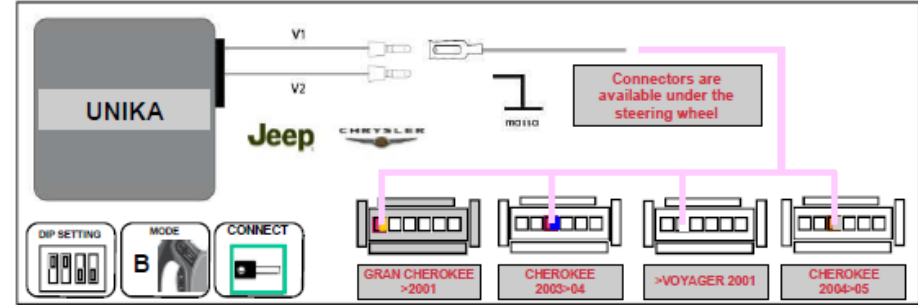
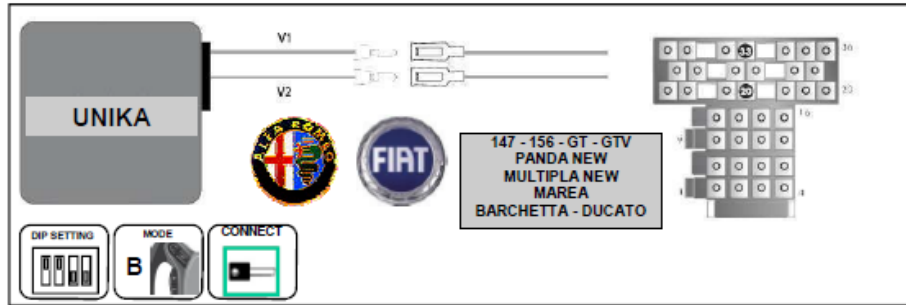

UNIKA PRODUCT INFO

UNIKA VEHICLE CONNECTIONS CONTINUED

RESISTIVE SYSTEMS

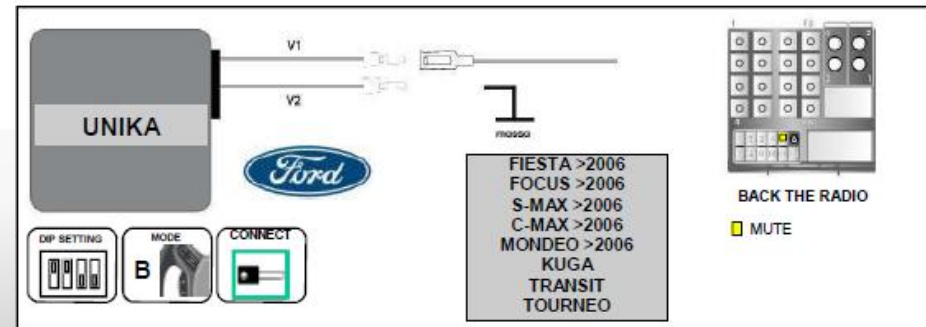
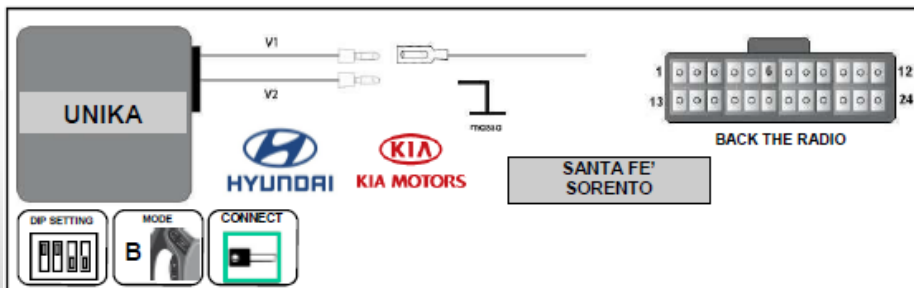
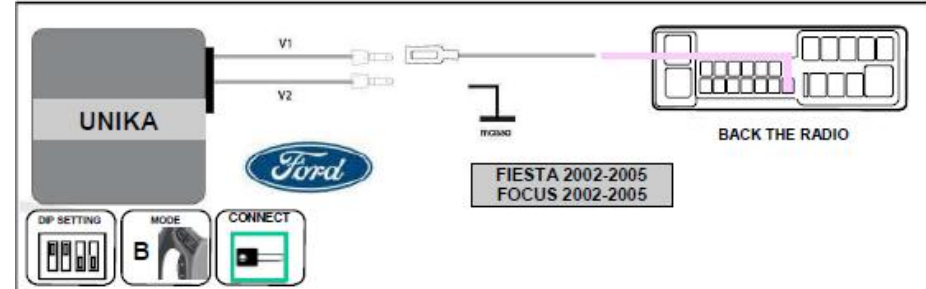
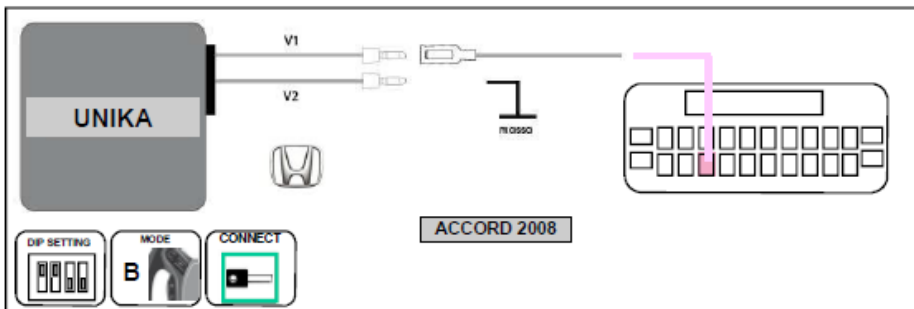
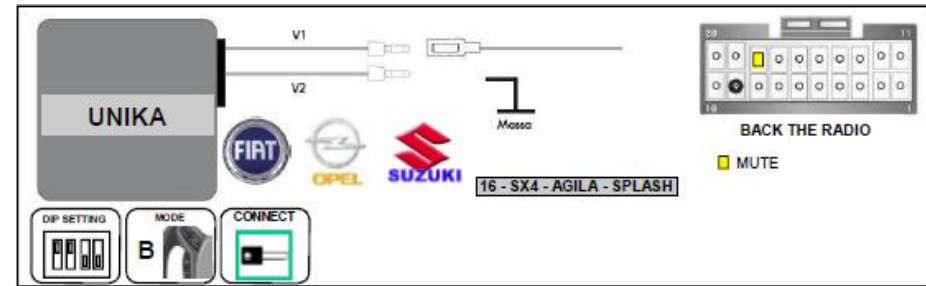
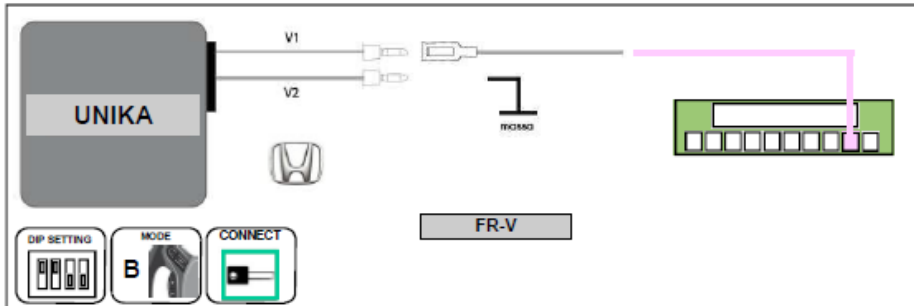

UNIKA PRODUCT INFO

UNIKA VEHICLE CONNECTIONS CONTINUED

RESISTIVE SYSTEMS

